







 <p>Left Side:1Pc</p>	 <p>Right Side:1Pc</p>	 <p>Door Frame:1Pc</p>	 <p>Back Plate:1Pc</p>	 <p>Top Plate:1Pc</p>	 <p>Middle Plate:3Pcs</p>	 <p>Door Pivot: A 1Pcs B 8Pcs</p>	 <p>Self-tapping Screw(5x12): 10Pcs</p>
				 <p>Bottom Plate:1Pc</p>	 <p>Door:4Pcs</p>	 <p>"7"Shape Door Pivot:4Pcs</p>	 <p>Key:4 Sets</p>

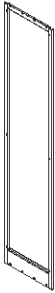
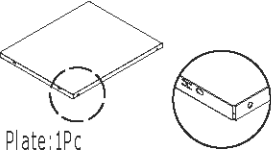
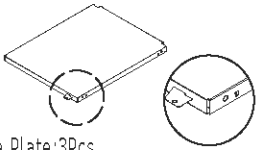
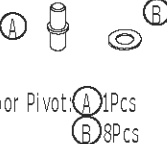
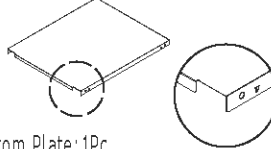
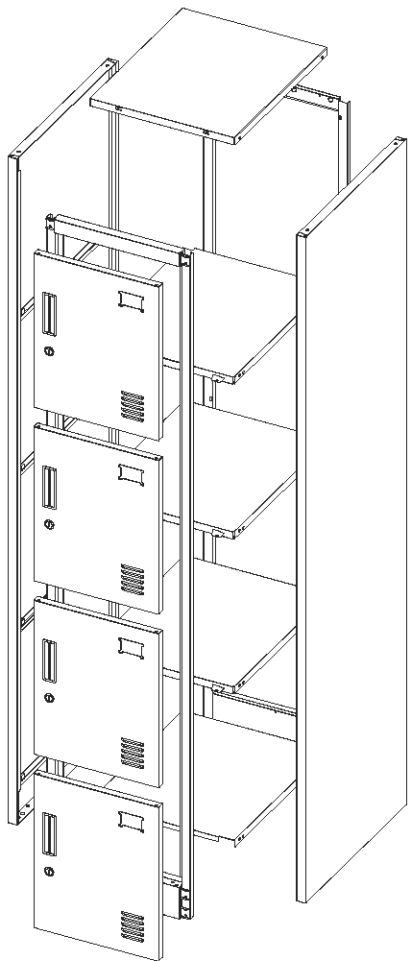
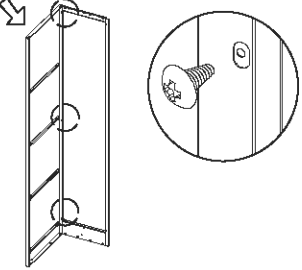
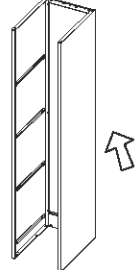
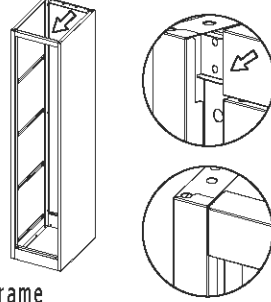
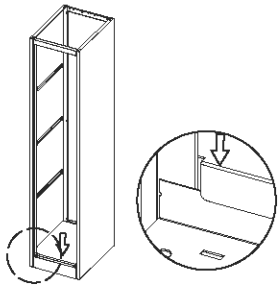
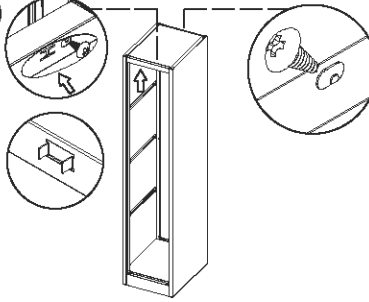
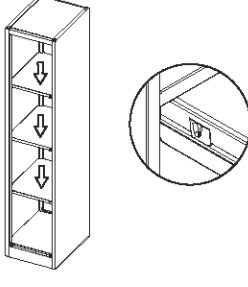
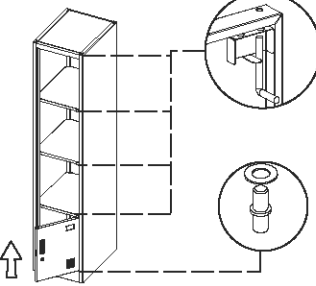
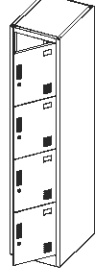
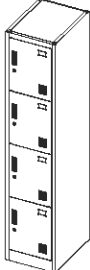

<p>①</p>  <p>Bolt the left side and back plate with self-tapping screws(5x12)</p>	<p>②</p>  <p>Bolt the right side with back plate in the same way as the first step</p>	<p>③</p>  <p>Fix the door frame onto both of the side plates</p>
<p>④</p>  <p>Install the bottom plate as the sign.</p>	<p>⑤</p>  <p>Install the top plate as the sign.</p>	<p>⑥</p>  <p>Install the middle plates</p>
<p>⑦</p>  <p>Install the doors from up to down</p>	<p>⑧</p>  <p>Adjust each part till fit well</p>	<p>⑨</p>  <p>Installation finished.</p>